

**Technische specificaties • Technical specifications • Technische Spezifikationen • Données techniques**

| Model<br><i>Model</i><br>Modell<br><i>Modèle</i> | Afmetingen<br>(lxbxh)<br><i>Dimensions</i><br>(lxwxh)<br>Maße (lxbxh)<br><i>Dimensions</i><br>(lxbxh) | Afstand borstbuis tot voorzijde punt<br><i>Distance from breast bar to front</i><br>Abstand Bruststange zur Vorderseite Spitze<br><i>Distance de la barre de poitrail jusqu'à la partie avant de la pointe</i> | Ledig gewicht<br><i>Tare weight</i><br>Leergewicht<br><i>Poids à vide</i> | Totaal gewicht<br><i>Total weight</i><br>Gesamtgewicht<br><i>Poids total</i> | Bandenmaat<br><i>Tyre size</i><br>Reifengröße<br><i>Dimensions des pneus</i> | Wandhoogte<br><i>Height of sides</i><br>Wandhöhe<br><i>Hauteur de paroi</i> | Hoogte borstbuis<br><i>Height of breast bar</i><br>Höhe Bruststange<br><i>Hauteur de la barre de poitrail</i> | Hoogte bilbuis<br><i>Height of buttock bar</i><br>Höhe Heckstange<br><i>Hauteur de la barre de recul</i> | Deelbaar tussenschot<br><i>Divided separation</i><br>Trennwand geteilt<br><i>Separation flexible</i> | Kogeldruk leeg/geladen<br><i>Tow hitch pressure empty/loaded</i><br>Stützlast leer/beladen<br><i>Charge d'appui sans/avec charge</i> | Dakluik<br><i>Roof-top-vent</i><br>Dachluffer<br><i>Ventilation a toit</i> |
|--|---|--|---|--|--|---|---|--|--|--|--|
|  | cm  | cm   | kg  | kg   |  | cm  | cm  |  |  | kg   |  |
| S77 polyester                                    | 360x171x245   | 165  | 900   | 2000/2500  | 185-70R13 / 195-65R12  | 170   | 120 en 100  | 110  | ○  | 40/80  | ●  |
| S77 aluminium with polyester front               | 360x171x245   | 165  | 900   | 2000/2500  | 185-70R13 / 195-65R13  | 170   | 120 en 100  | 110  | ○  | 40/80  | ●  |
| S77 aluminium                                    | 340x171x245   | 140  | 850   | 2000/2500  | 185-70R13 / 195-65R14  | 170   | 120 en 100  | 110  | ○  | 40/80  | ●  |
| S77-L aluminium                                  | 340x171x225   | 140  | 850   | 2000/2500  | 185-70R13 / 195-65R14  | 153   | 120 en 100  | 110  | ○  | 40/80  | ●  |
| S75 aluminium with polyester front               | 360x171x245   | 160  | 850   | 2000/2500  | 185-70R13 / 195-65R15  | 152.5   | 120 en 100  | 110  | ○  | 40/80  |  |
| S75 aluminium                                    | 340x171x245   | 140  | 850   | 2000/2500  | 185-70R13 / 195-65R15  | 152.5   | 120 en 100  | 110  | ○  | 40/80  |  |
| S45 aluminium                                    | 345x141x245   | 145  | 750   | 1600   | 185-70R13  | 152.5   | 120 en 100  | 110  | –  | 40/80  |  |
| S90 aluminium / S90-L aluminium                  | 490x171x250/230   | not applicable   | 1300  | 2000/2500/3000/3500  | 185-70R13 / 195-65R15 / 195-65R16  | 212.5   | 120 en 100  | 110  | ○  | 40/90  | ●  |
| S80 aluminium / S80-L aluminium                  | 340x171x250/230   | 140  | 875   | 2000/2500/3000/3500  | 185-70R13 / 195-65R15  | 212.5   | 120 en 100  | 110  | ○  | 50/88  | ●  |
| S70/S71 aluminium                                | 490x171x190/210   | not applicable   | 1200  | 2000/2500/3000/3500  | 185-70R13 / 195-65R15  | 152.5   | 120 en 100  | 110  | ○  | 50/87  | ●  |
| S60/S61 aluminium                                | 340x171x190/210   | 140  | 800   | 2000/2500/3000/3500  | 185-70R13 / 195-65R15  | 152.5   | 120 en 100  | 110  | ○  | 50/86  | ●  |
| S150 aluminium                                   | 375x171x240   | 90   | 950   | 2000/2500/3000/3500  | 185-70R13 / 195-65R15  | 240   | 120 en 100  | 110  | ●  | 75/100   | ●  |
| S170 aluminium                                   | 455x171x240   | 90   | 1100  | 2000/2500/3000/3500  | 185-70R13 / 195-65R15  | 240   | 120 en 100  | 110  | ●  | 75/100   | ●  |
| S190 aluminium                                   | 525x171x240   | 90   | 1300  | 2000/2500/3000/3500  | 195-65R15  | 240   | 120 en 100  | 110  | ●  | 75/100   | ●  |

**Kleurengamma**  
*Range of colours*  
**Farbskala**  
*Gammes de couleurs*



Blue metallic  
(Bl)



Silver metallic  
(S)

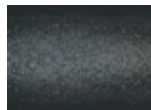

Anthracite metallic  
(A)



Black metallic  
(Bk)



Nara Bronze metallic  
(Nb)



Cherry Red  
(Cr)



White (W)

| Deur/klep systeem<br><i>Door/ramp combination</i><br>Tür-/Rampe-kombination<br><i>Système pont/porte</i> | Grote instapdeur<br><i>Large entrance door</i><br>Größe Einstiegtür<br><i>Grande porte d'embarquement</i> | Zwaar automatisch neuswiel<br><i>Heavy automatic nose wheel</i><br>Schweres automatisches Stützrad<br><i>Roue jockey automatique lourde</i> | Alu-compound vloer<br><i>Alu-compound floor</i><br>Alu-compound Boden<br><i>Plancher en Alu-compound</i> | Ergonomische borstbuis<br><i>Ergonomic breast bar</i><br>Ergonomische Brust Polsterung<br><i>Barre de poitrail ergonomique</i> | Automatisch achterzeil<br><i>Automatic canvas</i><br>Automatische Planenrollo<br><i>Bâche arrière automatique</i> | Ventilerende ramen<br><i>Ventilating windows</i><br>Ventilierende Fenster<br><i>Hublots ventilantes</i> | Verticale powersteun voorzijde<br><i>Vertical power support front</i><br>Vertikale Kraftunterstützung Vorderseite<br><i>Forces verticales auprès de la barre de poitrail</i> | Tunnel over deursluiting<br><i>Tunnel over door latch</i><br>Tunnel über Türverschluss<br><i>Tunnel au-dessus de la fermeture de porte</i> | Leverbare kleuren<br><i>Available colours</i><br>Lieferbare Farben<br><i>Couleurs livrables</i> | <i>Begaanbare zadelkamer/ kleedruimte</i><br><i>Saddleroom / dressing room</i><br><i>Begehrbarer Sattel Kammer / Umkleideraum</i><br><i>Sellerie / Vestiaire</i> |                  |
|--|---|---|--|--|---|---|--|--|---|--|------------------|
| •  | •   | •   | •  | •  | •   | •   | •  | •  | •   | BI/S/A/Bk/Nb/Cr/W  |                  |
| •  | •   | •   | •  | •  | •   | •   | •  | •  | •   | BI/S/A/Bk/Nb/Cr/W  |                  |
| •  | •   | •   | •  | •  | •   | •   | •  | •  | •   | BI/S/A/Bk/Cr   |                  |
| •  | •   | •   | •  | •  | •   | •   | •  | •  | •   | BI/S/A/Bk/Cr   |                  |
| •  | •   | •   | •  | •  | •   | •   | •  | •  | •   | BI/S/A/Bk  |                  |
| •  | •   | •   | •  | •  | •   | •   | •  | •  | •   | BI/S/A/Bk  |                  |
| •  | •   | •   | •  | •  | •   | •   | •  | •  | •   | BI/S/A/Bk  |                  |
| •  | •   | •   | •  | •  | •   | •   | •  | •  | •   | BI/S/A/Bk  |                  |
| •  | ○   | •   | •  | •  | •   | ○   | •/Interior   | •  | •   | BI/S/A/Bk  |                  |
| •  | ○   | •   | •  | •  | •   | ○   | •  | •  | •   | BI/S/A/Bk  |                  |
| •  | ○   | •   | •  | •  | •   | ○   | •/Interior   | •  | •   | BI/S/A/Bk  |                  |
| •  | ○   | •   | •  | •  | •   | ○   | •  | •  | •   | BI/S/A/Bk  |                  |
| •  | •   | •   | •  | •  | •   | hard cover  | •  | •/Interior   | •   | Bk   | • 90x171x240 cm  |
| •  | •   | •   | •  | •  | •   | hard cover  | •  | •/Interior   | •   | Bk   | • 160x171x240 cm |
| •  | •   | •   | •  | •  | •   | hard cover  | •  | •/Interior   | •   | Bk   | • 160x171x240 cm |

● = standard ○ = option -- = not available

**www.jm-anhänger.at**

**Johannes Mittendrein**  
Tel. 0664/86 76 126  
office@jm-anhänger.at

**Anhänger Verkauf**

Walkersdorf 80 - 8262 Ilz



Technische tekeningen • Technical diagrams • Technische Zeichnungen • Dessins techniques

Zijaanzichten  
 Side view  
 Ansichten von der Seite  
 Vues latérales

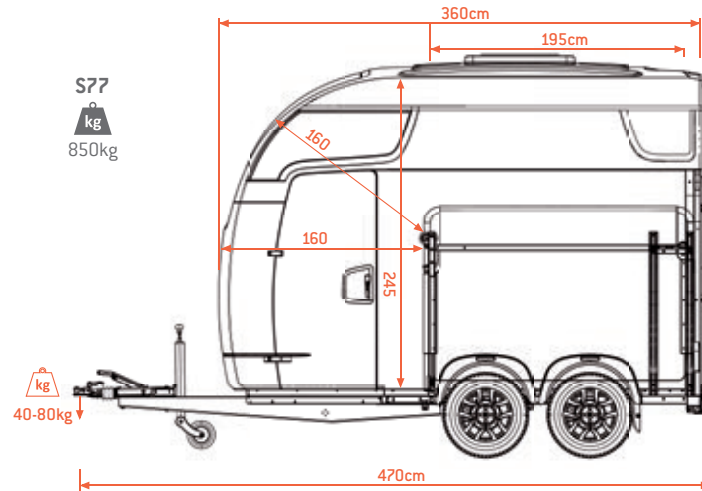

S77 Polyester or Aluminium with polyester front

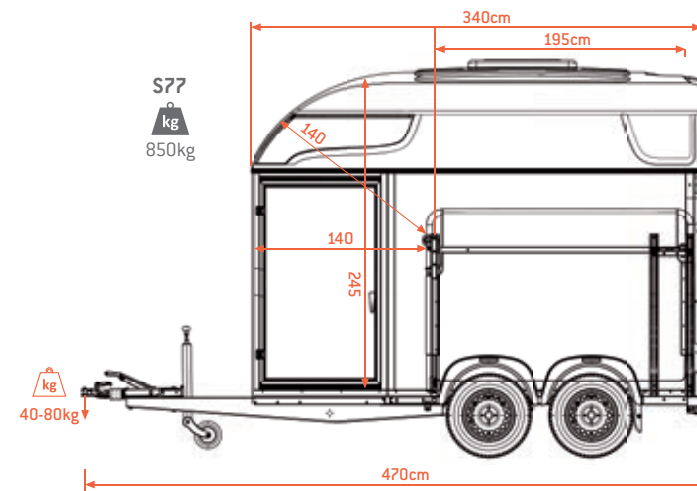

S77 Aluminium

Bovenaanzichten  
 Overhead views  
 Ansichten von oben  
 Vues d'en haut

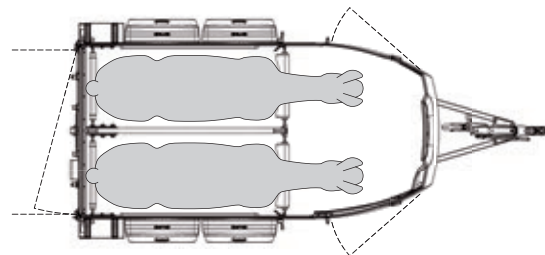

S77 Polyester/aluminium with polyester front

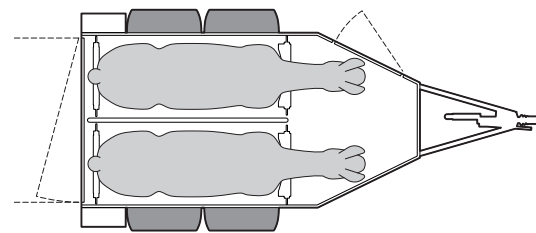

S75 Basic 2 horses  
 S77 Aluminium

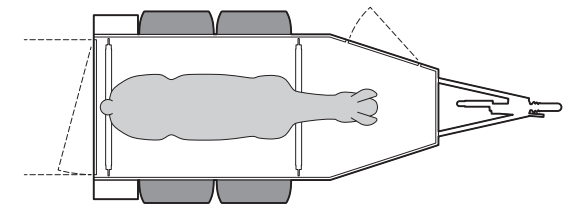

S45 Basic 1 horse

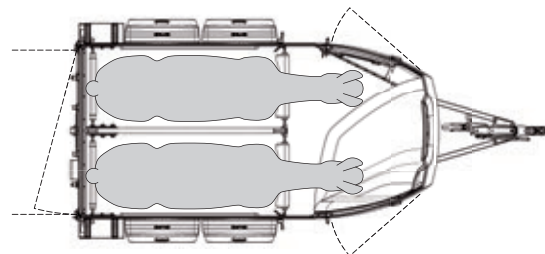

S77 Polyester/aluminium with polyester front  
 with tack room

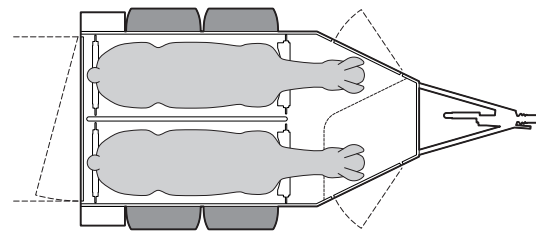

S75 With tack room 2 horses  
 S77 Aluminium with tack room 2 horses

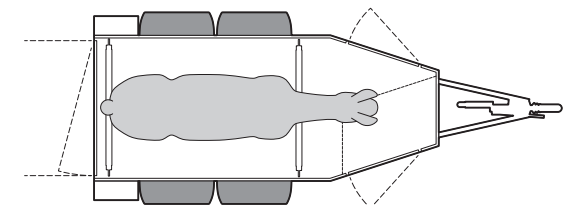

S45 With tack room 1 horse

Bovenaanzichten • Overhead views • Ansichten von oben • Vues d'en haut

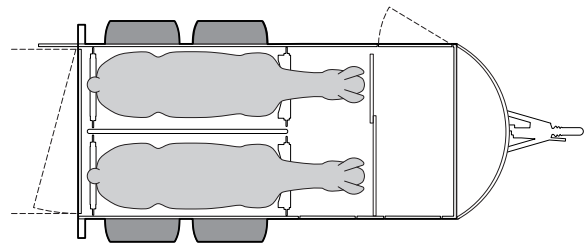

S150 Aluminium

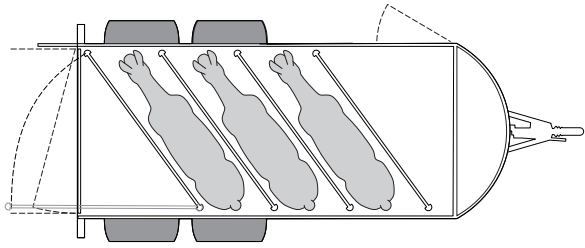

S150 Islandic

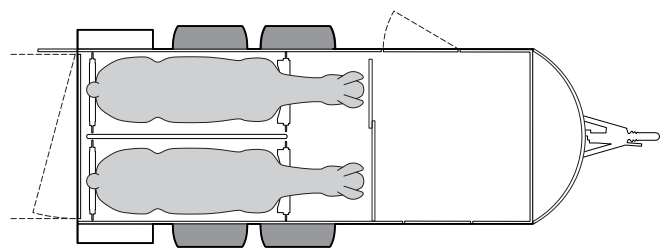

S170 Aluminium

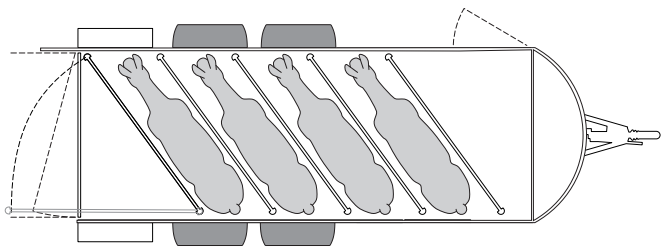

S170 Islandic

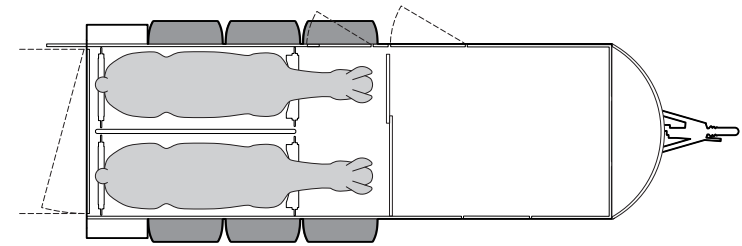

S190 Aluminium

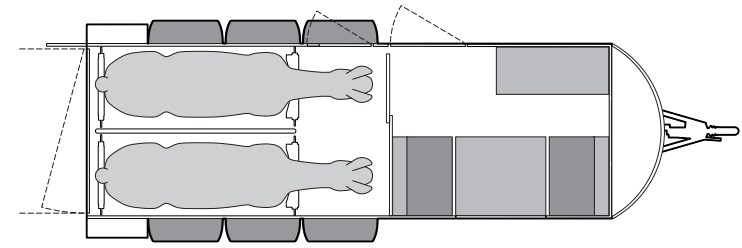

S190 Living

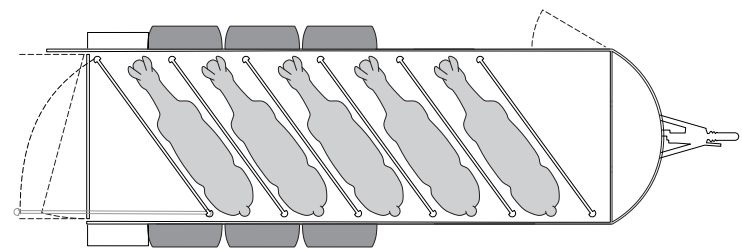

S190 Islandic

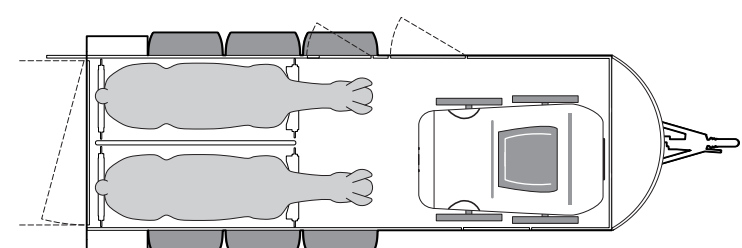

S190 Carriage

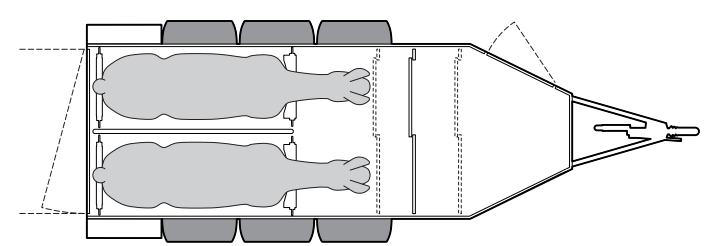

S90 Living

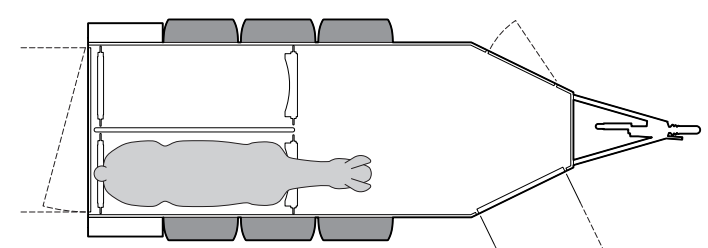

S90 Front exit

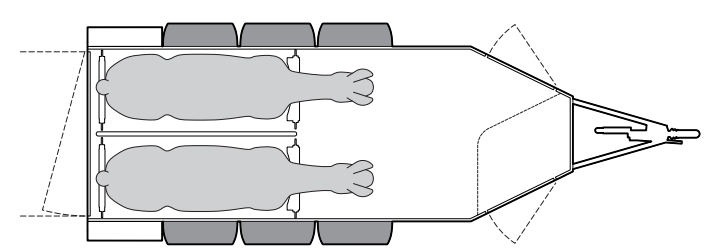

S90 With tack room

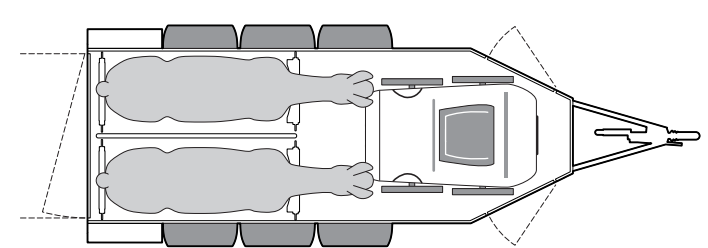

S90 Carriage

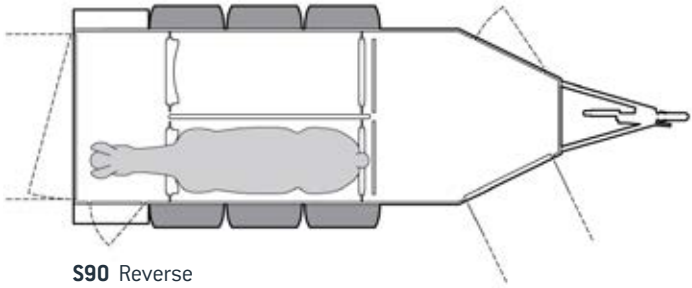

**S90** Reverse

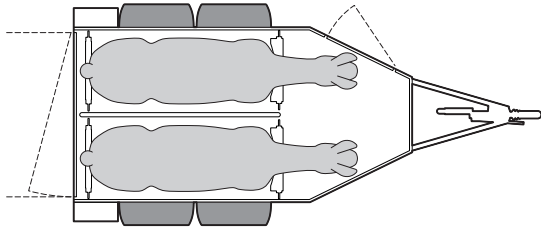

**S80** Basic 2 horses

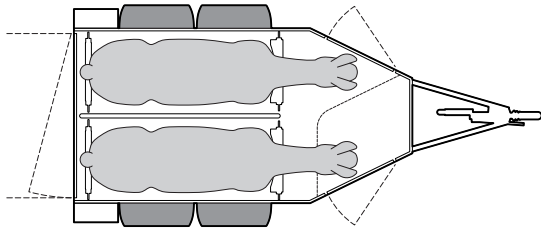

**S80** With tack room 2 horses

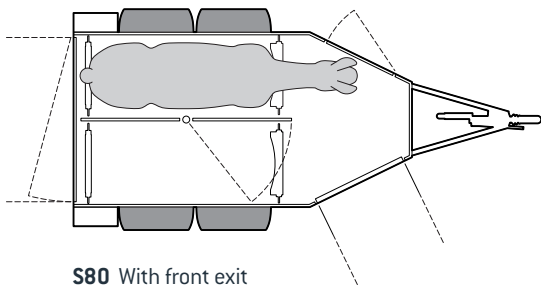

**S80** With front exit

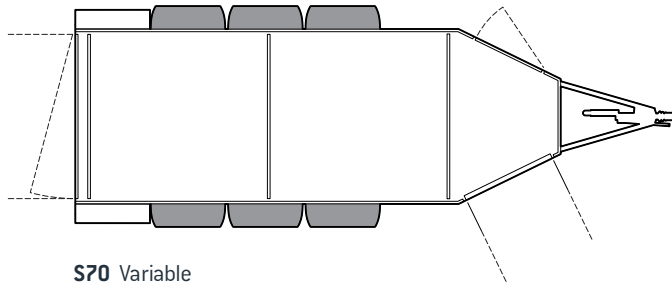

**S70** Variable

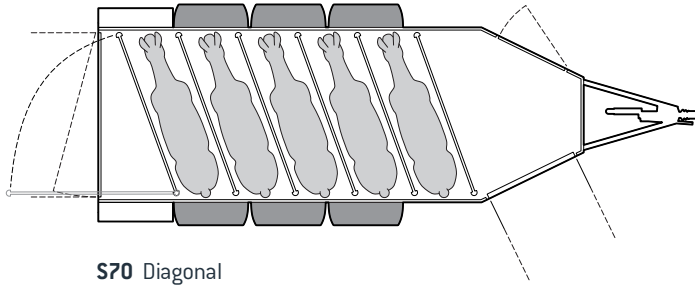

**S70** Diagonal

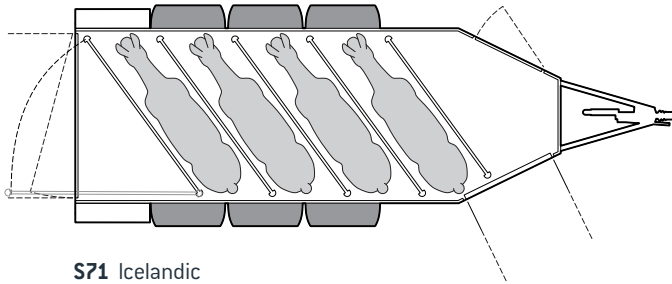

**S71** Icelandic

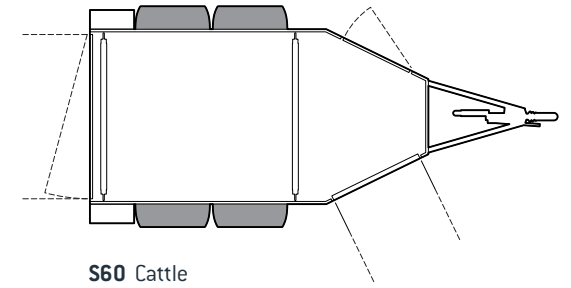

**S60** Cattle

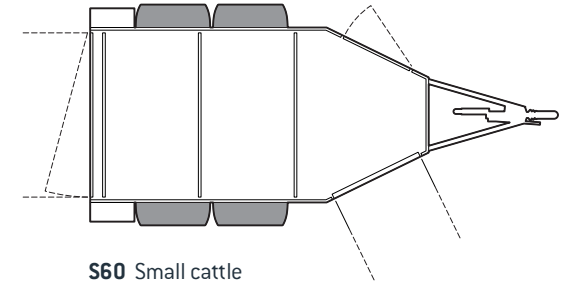

**S60** Small cattle

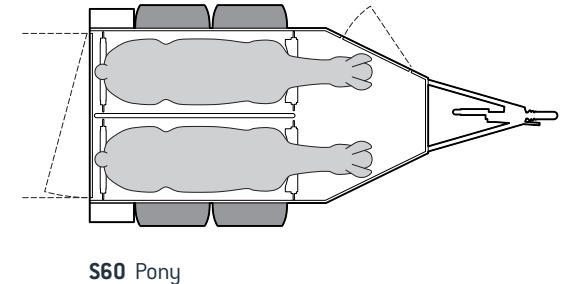

**S60** Pony

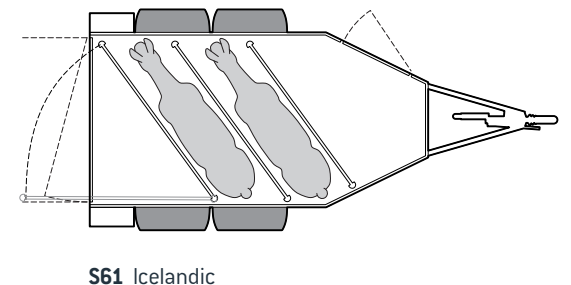

**S61** Icelandic

**www.jm-anhänger.at**

**Johannes Mittendrein**  
 Tel. 0664/86 76 126  
 office@jm-anhänger.at

**Anhänger Verkauf**

Walkersdorf 80 - 8262 Ilz